

Guided Cylinder STM Series

GUIDED CYLINDER STM SERIES



Super-Mini Complete with

Super-mini Guided Cylinder STM Series ($\varnothing 6$, $\varnothing 10$) with free installation and wide variations to facilitate use and selection

Product lineup including ball bearing and clean-room specifications

High-performance guide

The structure features an outstanding rod revoluble angle tolerance of $\pm 0.08^\circ$, high rigidity, and tolerance against lateral loads.

* For ball bearing type (STM-B)

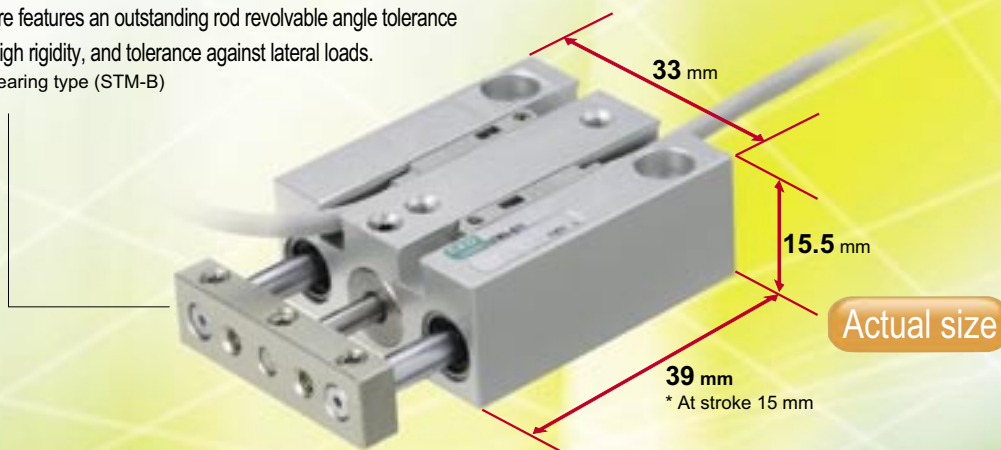

Super-mini

Smallest model is just 33 mm wide and 15.5 mm high. This is the smallest space-saving guided cylinder available.

Guided Cylinder

STM Series



Easy-to-Use Functions

Piping direction

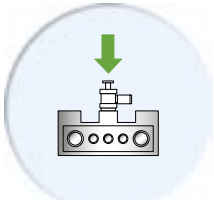

1 Front piping

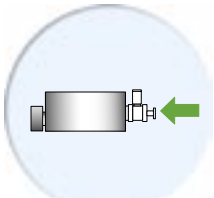

2 Rear piping (option)

Installation direction

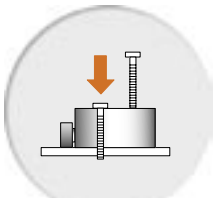

1 Front installation

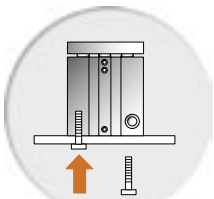

2 Head end installation

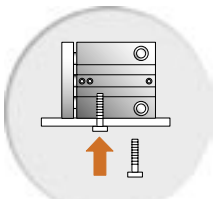

3 Side installation (option)

Piping to rear and installed on side

Piping is connected to the front or centrally led from the rear. (Option)

Installation on the cylinder is possible, allowing several units to be installed in a small space. (Option)

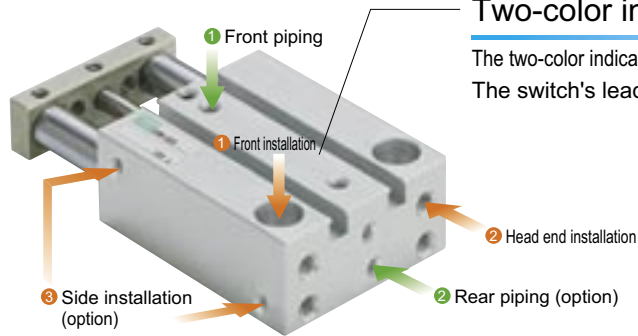

Two-color indicator switch installable

The two-color indicator reed switch can be installed on all types. The switch's lead is led out horizontally or vertically.

* All options are shown in the photo for explanatory purposes.

On the actual product, if the side installation option is selected, the head end installation is not provided.

This also applies to the piping option.

Two bearings

Metal bush bearings or ball bearings can be used based on the application.

Clean-room compatible

Clean-room specifications (STM-B-P7) are available.

Transfer compact parts, etc.

Ideal for use on compact part transfer lines, including precision devices such as semiconductors. This cylinder can be used in a variety of applications including positioning, stoppers, clamps, press-fitting, lifters, and pushers.

RoHS-compliant

Substances such as lead and hexavalent chrome that could adversely affect the global environment have been removed.

RoHS

Applicable fields

This cylinder can be used in the following manufacturing processes.

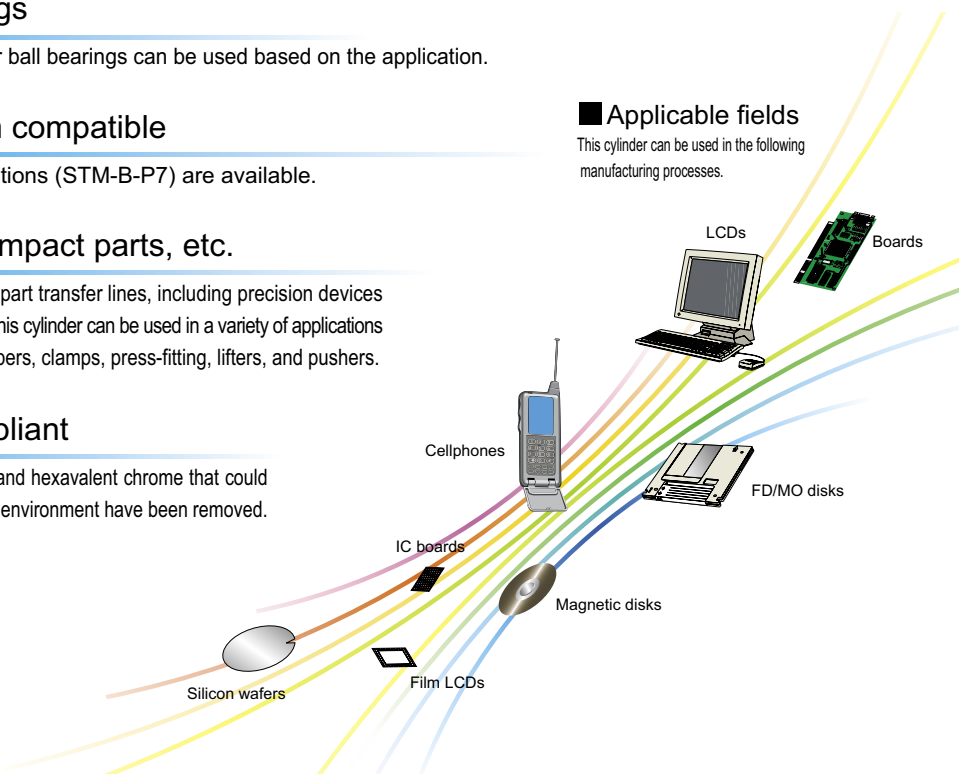

STM Series variation

Variation	Bore size	Stroke length (mm)				Option		Related products
		5	10	15	20	Side installation A	Rear piping R	
Metal bush bearing STM-M Series	ø6	●	●	●	●	●	●	<ul style="list-style-type: none"> ● Detection switch (F switch) ● Two-color indicator cylinder switch series ● Piping tube ● Air fiber ● Dedicated joint
	ø10	●	●	●	●	●	●	
Ball bearing STM-B Series	ø6	●	●	●	●	●	●	
	ø10	●	●	●	●	●	●	
Clean-room specifications STM-B-P7 Series	ø6	●	●	●	●	●	●	
	ø10	●	●	●	●	●	●	

* Only ball bearings

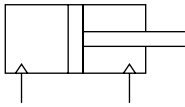
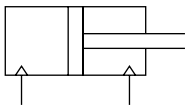

Variation	Model no. JIS symbol	Bore size (mm)	Stroke length (mm)			
			5	10	15	20
Double acting single rod type	STM-M/B 	ø6	●	●	●	
		ø10	●	●	●	●
Double acting single rod type Clean room specifications	STM-B-P7* 	ø6	●	●	●	
		ø10	●	●	●	●

Note 1: Consult with CKD for combinations of clean room specifications and rear piping type.

●: Standard ◎: Option ■: Not available

	Max. stroke length (mm)	Type of bearing		Option		Switch	Page
		Metal bush bearing M	Ball bearing B	Side installation type A	Rear piping type R		
	15	●	●	●	●	◎	1
	20	●	●	●	●	◎	
	15	■	●	●	Note 1	◎	7
	20	■	●	●	Note 1	◎	



Safety precautions

Always read this section before starting use.

When designing and manufacturing a device using CKD products, the manufacturer is obligated to check that device safety mechanism, pneumatic control circuit, or water control circuit and the system operated by electrical control that controls the devices is secured.

It is important to select, use, handle, and maintain the product appropriately to ensure that the CKD product is used safely.

Observe warnings and precautions to ensure device safety.

Check that device safety is ensured, and manufacture a safe device.

WARNING

1 This product is designed and manufactured as a general industrial machine part. It must be handled by an operator having sufficient knowledge and experience in handling.

2 Use this product in accordance with specifications.

This product must be used within its stated specifications. It must not be modified or machined.

This product is intended for use as a general-purpose industrial device or part. It is not intended for use outdoors or for use under the following conditions or environment.

(Note that this product can be used when CKD is consulted prior to use and the customer consents to CKD product specifications. The customer must provide safety measures to avoid risks in the event of problems.)

① Use for special applications including nuclear energy, railway, aircraft, marine vessel, vehicle, medicinal devices, devices coming into contact with beverages or foodstuffs, amusement devices, emergency cutoff circuits (cutoff, open, etc.), press machines, brake circuits, or safety devices.

② Use for applications where life or assets could be adversely affected, and special safety measures are required.

3 Observe corporate standards and regulations, etc., related to the safety of device design and control, etc.

ISO4414, JIS B8370 (pneumatic system rules)

JFPS2008 (principles for pneumatic cylinder selection and use)

Including High Pressure Gas Maintenance Law, Occupational Safety and Sanitation Laws, other safety rules, body standards and regulations, etc.

4 Do not handle, pipe, or remove devices before confirming safety.

① Inspect and service the machine and devices after confirming safety of the entire system related to this product.

② Note that there may be hot or charged sections even after operation is stopped.

③ When inspecting or servicing the device, turn off the energy source (air supply or water supply), and turn off power to the facility. Discharge any compressed air from the system, and pay enough attention to possible water leakage and leakage of electricity.

④ When starting or restarting a machine or device that incorporates pneumatic components, make sure that the system safety, such as pop-out prevention measures, is secured.

5 Observe warnings and cautions on the pages below to prevent accidents.

■ The precautions are ranked as "DANGER", "WARNING" and "CAUTION" in this section.

 **DANGER:** When a dangerous situation may occur if handling is mistaken leading to fatal or serious injuries, or when there is a high degree of emergency to a warning.

 **WARNING:** When a dangerous situation may occur if handling is mistaken leading to fatal or serious injuries.

 **CAUTION:** When a dangerous situation may occur if handling is mistaken leading to minor injuries or physical damage.

Note that some items described as "CAUTION" may lead to serious results depending on the situation. In any case, important information that must be observed is explained.

Disclaimer

1. CKD cannot be held liable for any business interruption, loss of profit, personal injury, delay cost, or any other ancillary or indirect loss, cost, or damage resulting from the use of or faults in the use of CKD products.

2. CKD cannot be held responsible for the following damage:

① Damage resulting from disaster or failure of CKD parts due to fire from reasons not attributable to CKD, or by intentional or negligence of a third party or customer.

② When a CKD product is assembled into customer equipment, damage that could have been avoided if customer equipment were provided with functions and structure, etc., generally accepted in the industry.

③ Damage resulting from use exceeding the scope of specifications provided in CKD catalogs or instruction manuals, etc., or from actions not following precautions for installation, adjustment, or maintenance, etc.

④ Damage resulting from product modifications not approved by CKD, or from faults due to combination with other software or other connected devices.



Pneumatic components

Safety precautions

Always read this section before starting use.

Refer to Pneumatic Cylinders (CB-029SA) for details on general cylinders and cylinder switches.

Precautions: Guided Cylinder STM Series

Design & Selection

1. Common

⚠ CAUTION

- When using the STM-B-6 with a two-color indicator reed switch, the cylinder cannot be installed on a magnetized device (steel plates, etc.). Installation will result in switch detection faults.

2. With switch

⚠ CAUTION

- Observe tightening torque when installing the switch.
Installation screws, bracket or switch, etc., could be damaged if tightening torque range is exceeded. Insufficient torque could cause the switch installation position to deviate.
Tightening torque: 29.4 (N·mm)

3. Clean room specifications

⚠ CAUTION

- Precautions for using relief ports
Exhaust gas (P72) cannot be treated with vacuum sweeping. This also applies for the reverse application. Do not use for this type of application because it could result in particle scattering or faults.

Installation & Adjustment

1. Common

⚠ CAUTION

- Install a flow control valve when piping. When installing rear piping with a through bolt, the following joints can be used:

Bore size	Port size	Applicable joint/ Flow control valve	Joint O.D. D
ø6 ø10	M3	SC3W-M3-*	ø8
		SC3WU-M3-*	
		FTS4-M3	
		FTL4-M3	
		GWS*-M3-S	
		PTN2-M3 PTNL-M3	

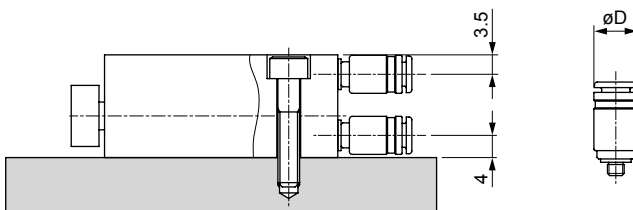

- Check that no dents or damage are on the tube installation surface or end plates that could compromise flatness. Flatness on the counterpart side on which the end plate is installed must be 0.02 mm or less.

- When installing a jig, etc. on the end plate, check that the bolt's screw-in length is equivalent to Y dimensions. Failure to do so could damage the end plate.

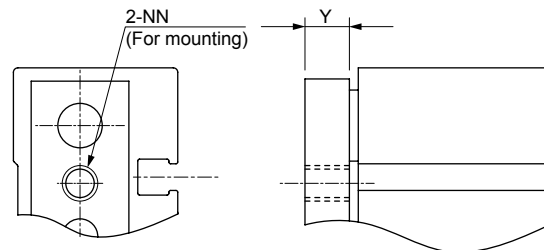

Bore size (mm)	Y dimension
ø6	5
ø10	

Installation & Adjustment

- A rubber cushion is assembled into the cylinder. The following table shows kinetic energy absorbed by the cushion. If kinetic energy exceeds these values, consider using another cushion.

Bore size (mm)	Allowable energy absorption (J)
ø6	0.008
ø10	0.054

- When installing with a bolt, tighten with the following tightening torque:

Bore size (mm)	Thread size	Tightening torque (N·m)	
		Through bolt	Side installation
ø6	M3	1.1	0.6
ø10	M4	2.7	1.6

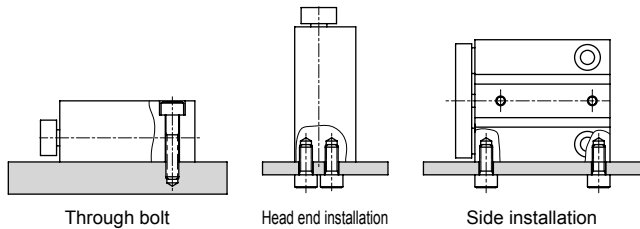

- When installing a workpiece on the end plate, tighten them with the following tightening torque:

Bore size (mm)	Thread size	Tightening torque (N·m)
ø6	M3	0.6
ø10	M4	1.6

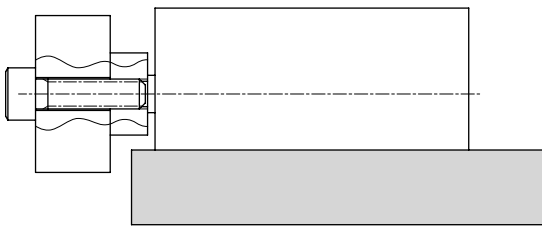

2. With switch

- If a magnetized device (steel plate, etc.) is near the cylinder switch, the cylinder switch could malfunction. Keep all magnetic materials at least 20 mm from the cylinder. (Same for all bore sizes.)

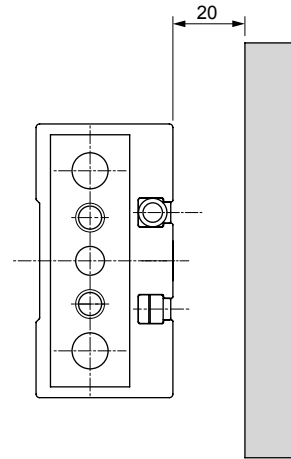

- The cylinder switch may malfunction if cylinders are installed adjacently. Separate cylinders by the following distance. (Same for all bore sizes.)

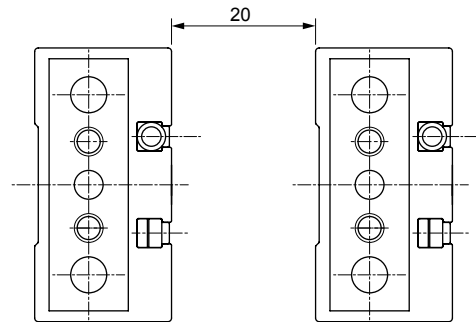

3. Clean room specifications

- Open the product in a clean room.
 - This product is packaged in a clean room. The package should be opened just before piping in the clean room.

During Use & Maintenance

1. Clean room specifications

WARNING

- Fluoro grease is used in P7 series. Lighting a cigarette with fluorine-based grease on hands generates toxic gases.

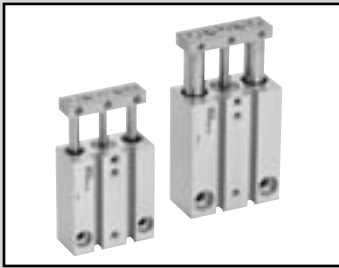

Guided cylinder Double acting single rod type

STM-M/B Series

● Bore size: $\varnothing 6$, $\varnothing 10$

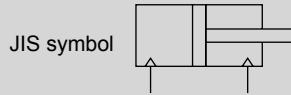

Specifications

Descriptions	STM-M/B	
	$\varnothing 6$	$\varnothing 10$
Bore size mm	$\varnothing 6$	$\varnothing 10$
Actuation	Double acting	
Working fluid	Compressed air	
Max. working pressure MPa	0.7	
Min. working pressure MPa	0.15	
Withstanding pressure MPa	1.05	
Ambient temperature °C	-10 to 60 (with no freezing)	
Port size	M3	
Stroke tolerance mm	+1.5 0	
Working piston speed mm/s	50 to 500	
Cushion	Rubber cushioned	
Lubrication	Not required (when lubricating, use turbine oil Class 1 ISO VG32.)	
Allowable energy absorption J	0.008	0.054

Stroke length

Bore size	Standard stroke length (mm)	Max. stroke length (mm)	Min. stroke length	Min. stroke length of types with switch
$\varnothing 6$	5, 10, 15	15	5	5
$\varnothing 10$	5, 10, 15, 20	20		

Note: Other than standard stroke length is custom order.

Switch specifications

Descriptions	Proximity 2-wire		Proximity 3-wire	
	F2H/F2V	F2YH/F2YV	F3H/F3V	F3YH/F3YV
Applications	Programmable controller dedicated		For programmable controller and relay	
Output method	-		NPN output	
Power voltage	-		10 to 28 VDC	
Load voltage	10 to 30 VDC	24 VDC \pm 10%	30 VDC or less	
Load current	5 to 20mA (Note 1)		50mA or less	
Light	LED (ON lighting)	Red/green LED (ON lighting)	LED (ON lighting)	Red/green LED (ON lighting)
Leakage current	1mA or less		10 μ A or less	

Note 1: The maximum load current 20mA is applied at 25°C. The current will be lower than 20mA if ambient temperature around switch is higher than 25°C.
(5 to 10mA at 60°C.)

Cylinder weight

Unit: g

Model no.	Stroke length (mm)	5	10	15	20	Weight per switch
	Bore size (mm)					
STM-M	ϕ 6	45.1	52.5	59.9	-	10
	ϕ 10	73.7	84.6	95.4	106.3	10
STM-B	ϕ 6	41.9	48.1	54.3	-	10
	ϕ 10	67.1	75.5	84.0	92.5	10

How to order

Without switch

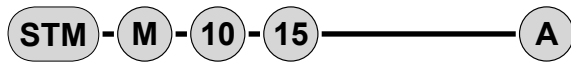

With switch

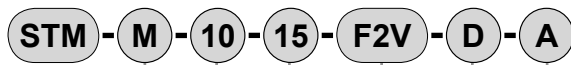

A Bearing method

B Bore size

C Stroke length

D Switch model no.

Note 1

E Switch quantity

F Option

⚠ Note on model no. selection

Note 1: When using the STM-B-6 with a two-color indicator reed switch, the cylinder cannot be installed on a magnetized device (steel plate, etc.). Installation will result in switch detection faults.

Symbol	Descriptions			
A Bearing method				
M	Metal bush bearing			
B	Ball bearing			
B Bore size (mm)				
6	ø6			
10	ø10			
C Stroke length (mm)				
		Bore size		
		6	10	
5	5	●	●	
10	10	●	●	
15	15	●	●	
20	20		●	
D Switch model no.				
Axial lead wire	Radial lead wire	Contact	Indicator	Lead wire
F2H*	F2V*	Proximity	1 color indicator type	2-wire
F3H*	F3V*			3-wire
F2YH*	F2YV*		2 color indicator type	2-wire
F3YH*	F3YV*			3-wire
*Lead wire length				
Blank	1 m (standard)			
3	3 m (option)			
E Switch quantity				
R	1 on rod end			
H	1 on head end			
D	2			
F Option				
A	Side installation type			
R	Rear piping type			

<Example of model number>

STM-M-10-15-F2H-D-A

Model: Guided cylinder

- A Bearing method : metal bush bearing
- B Bore size : ø10 mm
- C Stroke length : 15 mm
- D Switch model no.: proximity switch F2H, lead wire 1 m
- E Switch quantity : 2
- F Option : Side installation type

How to order switch



Switch model no.
(item in D)

CKD

Internal structure and parts list

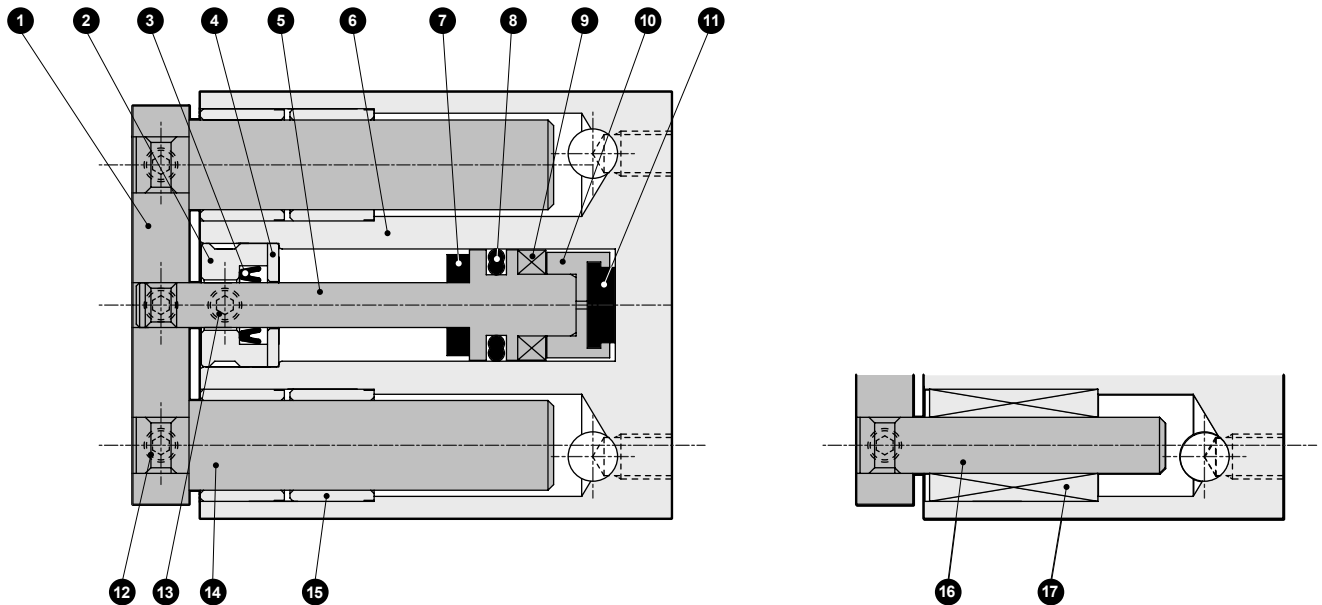

Metal bush bearing

Ball bearing

*This product can not be disassembled.

No.	Parts name	Material	Remarks	No.	Parts name	Material	Remarks
1	End plate	Aluminum alloy	Alumite	10	Adaptor	Aluminum alloy	Chromate
2	Rod bushing	Stainless steel		11	Cushion rubber H	Urethane rubber	
3	Rod packing seal	Nitrile rubber		12	Hexagon socket head set screw	Stainless steel	
4	Spacer	Aluminum alloy	Chromate	13	Hexagon socket head set screw	Stainless steel	
5	Piston	Stainless steel		14	Guide rod	Stainless steel	Industrial chrome plating (ø10)
6	Tube body	Aluminum alloy	Hard alumite	15	Metal	Oil impregnated copper alloy	
7	Cushion rubber R	Urethane rubber		16	Guide rod	Alloy steel	Industrial chrome plating
8	Piston packing seal	Nitrile rubber		17	Ball bearing		
9	Piston magnet						

Dimensions

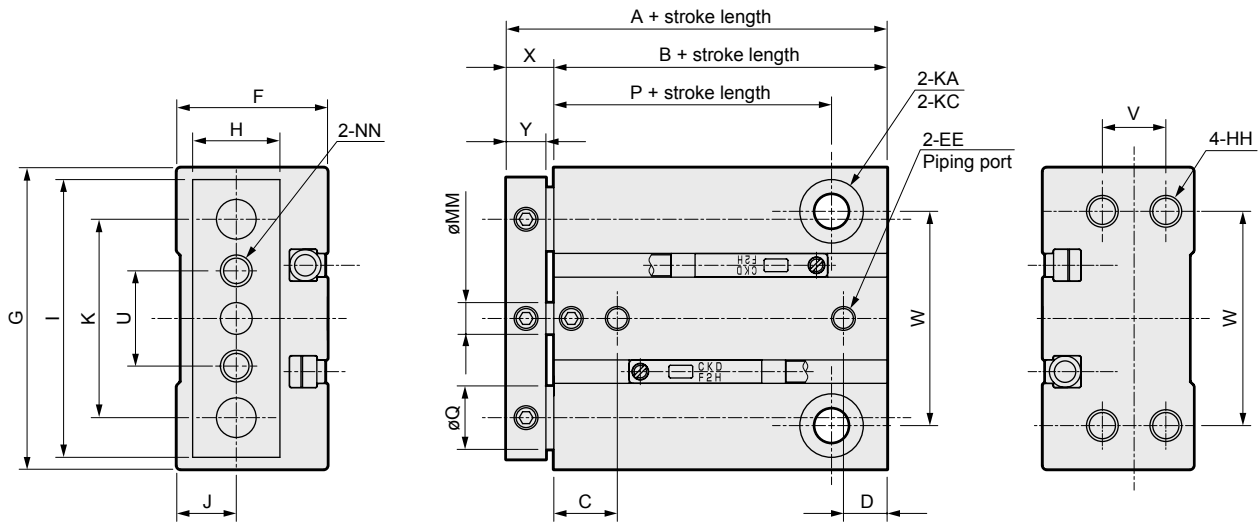

Symbol	Standard stroke length (mm)	A	B	C	D	EE	F	G	H	HH	I	J	K	KA
Bore size (mm)														
6	5, 10, 15	30	24	7.5	5	M3	15.5	33	9	M3 depth 5	31	6	23	3.4 penetrating
10	5, 10, 15, 20	34	28	8.5	7	M3	19	38	11	M4 depth 5	35	7.5	25	4.3 penetrating

Symbol	KC	MM	NN	P	Q		U	V	W	X	Y
Bore size (mm)					STM-M	STM-B					
6	6.1 spot face depth 3.3	3	M3 penetrating	17	6	4	12	6	25	6	5
10	8 spot face depth 4.4	4	M4 penetrating	20.5	8	5	12	8	27	6	5

Dimensions with options

- Side installation type (A)

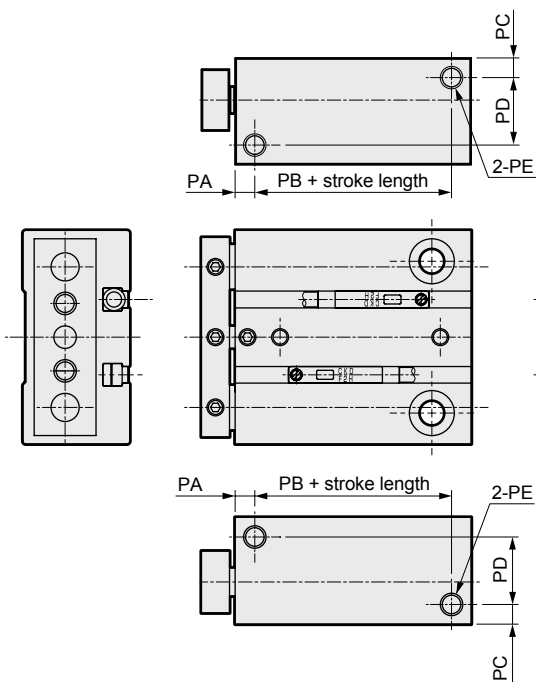

Symbol	Standard stroke length (mm)	PA	PB	PC	PD	PE
Bore size (mm)						
6	5, 10, 15	3	18	3	10	M3 depth 5
10	5, 10, 15, 20	4	21	4	12	M4 depth 5

Dimensions with options

● Rear piping type (R)

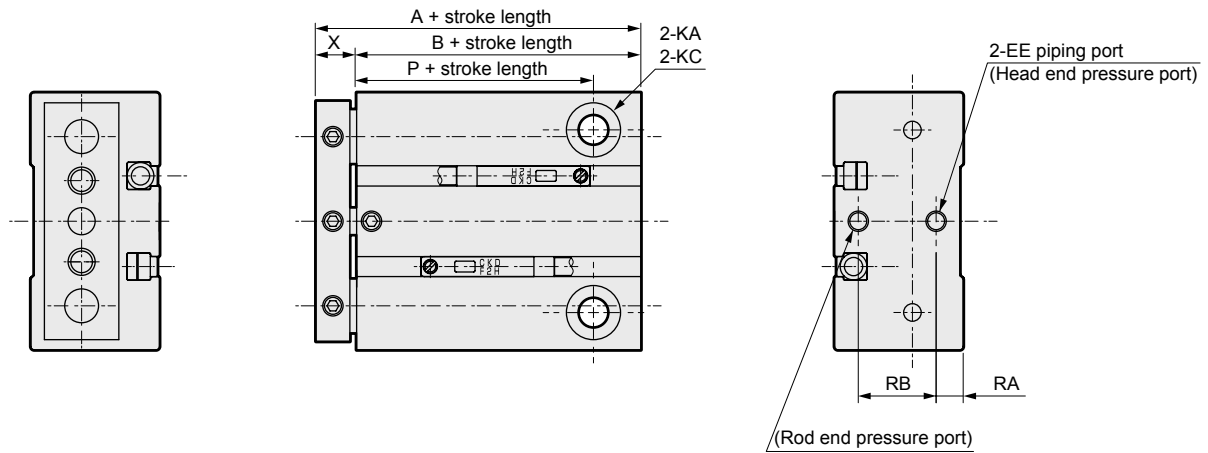

Symbol	Standard stroke length (mm)	A	B	EE	KA	KC	P	RA	RB
Bore size (mm)									
6	5, 10, 15	32	26	M3	3.4 penetrating	6.1 spot face depth 3.3	17	4	8
10	5, 10, 15, 20	34	28	M3	4.3 penetrating	8 spot face depth 4.4	20.5	4	12

Switch installing position

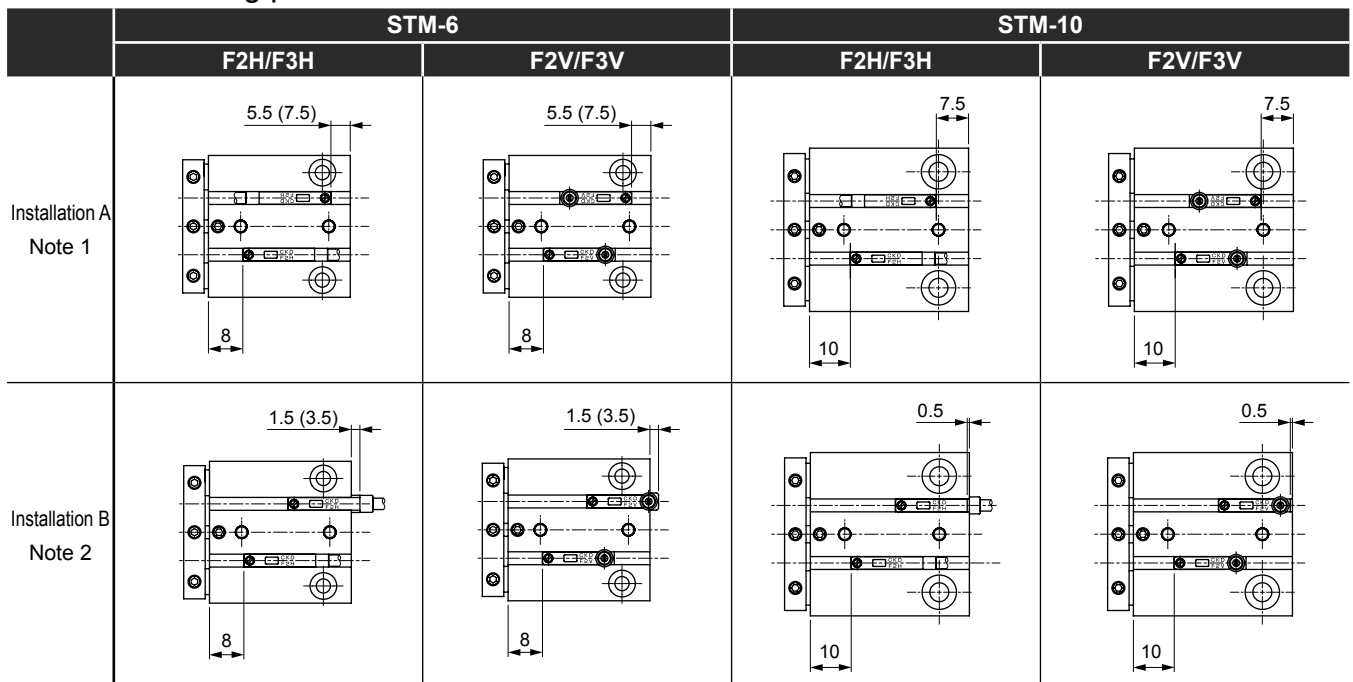

Note 1: The product is shipped in Installation A with the switch assembled.

Note 2: If the switch is installed as shown in Installation B, it may protrude from the main device.

If the switch protrudes from the cylinder and the product is installed on the head, the switch will interfere with the system.

Note 3: Dimensions in () apply to rear piping.

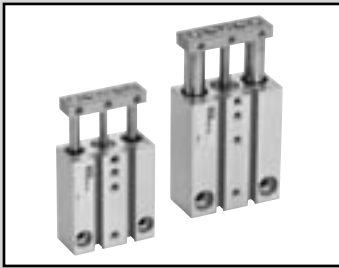

Guided cylinder Double acting single rod type Clean room specifications

STM-B-P7* Series

● Bore size: $\varnothing 6$, $\varnothing 10$

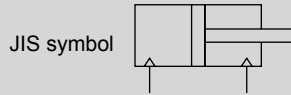

Specifications

Descriptions		STM-B	
Bore size	mm	$\varnothing 6$	$\varnothing 10$
Actuation		Double acting	
Working fluid		Compressed air	
Max. working pressure	MPa	0.7	
Min. working pressure	MPa	0.2	
Withstanding pressure	MPa	1.05	
Ambient temperature	°C	-10 to 60 (with no freezing)	
Port size		M3	
Relief port size		M3	
Stroke tolerance	mm	+1.5 0	
Working piston speed	mm/s	50 to 500	
Cushion		Rubber cushioned	
Lubrication		Not available	
Allowable energy absorption	J	0.008	0.054

Stroke length

Bore size	Standard stroke length (mm)	Max. stroke length (mm)	Min. stroke length	Min. stroke length of types with switch
$\varnothing 6$	5, 10, 15	15	5	5
$\varnothing 10$	5, 10, 15, 20	20		

Note: Other than standard stroke length is custom order.

Switch specifications

Descriptions	Proximity 2-wire		Proximity 3-wire	
	F2H/F2V	F2YH/F2YV	F3H/F3V	F3YH/F3YV
Applications	Programmable controller dedicated		For programmable controller and relay	
Output method	-		NPN output	
Power voltage	-		10 to 28 VDC	
Load voltage	10 to 30 VDC	24 VDC ±10%	30 VDC or less	
Load current	5 to 20mA (Note 1)		50mA or less	
Light	LED (ON lighting)	Red/green LED (ON lighting)	LED (ON lighting)	Red/green LED (ON lighting)
Leakage current	1mA or less		10µA or less	

Note 1: The maximum load current 20mA is applied at 25°C. The current will be lower than 20mA if ambient temperature around switch is higher than 25°C. (5 to 10mA at 60°C.)

Cylinder weight

Unit: g

Model no.	Stroke length (mm)	5	10	15	20	Weight per switch
	Bore size (mm)					
STM-B	ø6	56.2	62.5	68.7	-	10
	ø10	87.9	96.4	104.8	113.3	10

STM-B-P7* Series

How to order

Without switch



With switch

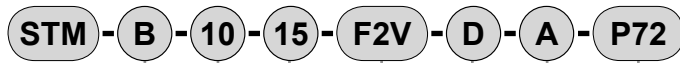

A Bearing method

B Bore size

C Stroke length

D Switch model no.
Note 1

E Switch quantity

F Option

G Clean room specifications

⚠ Note on model no. selection

Note 1: When using the STM-B-6-P72/P73 with a two-color indicator reed switch, the cylinder cannot be installed on a magnetized device. (steel plate, etc.) Installation will result in switch detection faults.

<Example of model number>

STM-B-10-15-F2H-D-A-P72

Model: Guided cylinder

- A** Bearing method : Ball bearing
- B** Bore size : $\varnothing 10$ mm
- C** Stroke length : 15 mm
- D** Switch model no.: proximity switch F2H, lead wire 1 m
- E** Switch quantity : 2
- F** Option : Side installation type
- G** Clean room specifications: Exhaust treatment

How to order switch

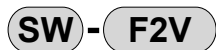

Switch model no.
(item in **D**)

CKD

Symbol	Descriptions			
A Bearing method				
B	Ball bearing			
B Bore size (mm)				
6	$\varnothing 6$			
10	$\varnothing 10$			
C Stroke length (mm)				
			Bore size	
			6	10
5	5	● ●		
10	10	● ●		
15	15	● ●		
20	20	●		
D Switch model no.				
Axial lead wire	Radial lead wire	Contact	Indicator	Lead wire
F2H*	F2V*	Proximity	1 color indicator type	2-wire
F3H*	F3V*			3-wire
F2YH*	F2YV*		2 color indicator type	2-wire
F3YH*	F3YV*			3-wire
*Lead wire length				
Blank	1 m (standard)			
3	3 m (option)			
E Switch quantity				
R	1 on rod end			
H	1 on head end			
D	2			
F Option				
A	Side installation type			
G Clean room specifications				
Structure				
P72	Exhaust treatment			
P73	Vacuum treatment			

Dimensions

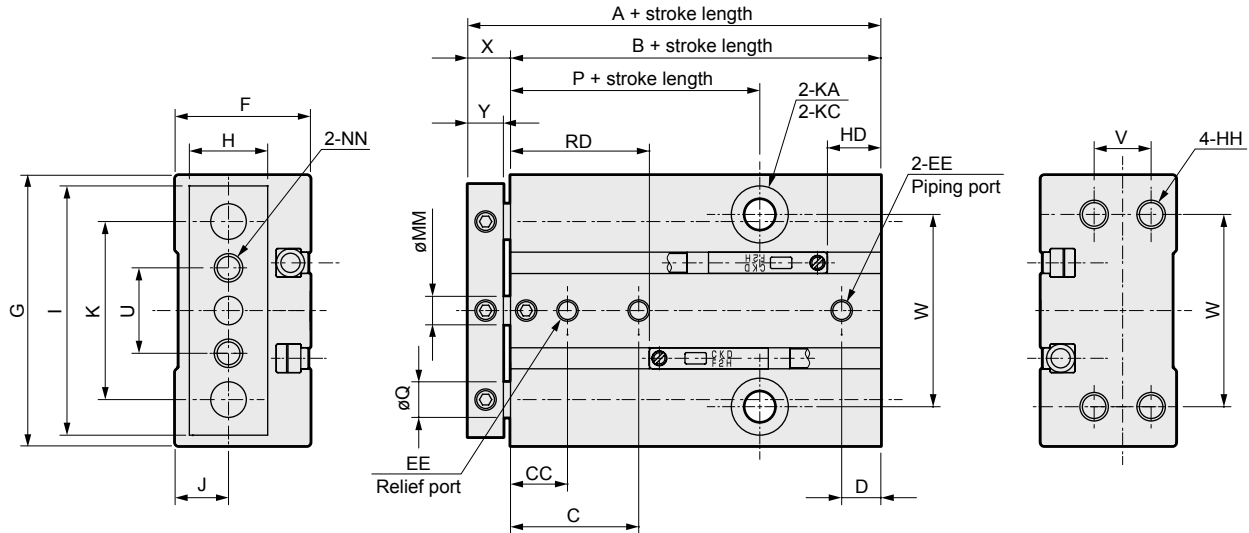

Symbol	Standard stroke length (mm)	A	B	C	CC	D	EE	F	G	H	HH	I	J	K	KA
Bore size (mm)															
6	5, 10, 15	40	34	17.5	7.5	5	M3	15.5	33	9	M3 depth 5	31	6	23	3.4 penetrating
10	5, 10, 15, 20	44	38	18.5	8.5	7	M3	19	38	11	M4 depth 5	35	7.5	25	4.3 penetrating
Symbol	KC		MM	NN	P	Q	U	V	W	X	Y	RD	HD		
Bore size (mm)															
6	6.1 spot face depth 3.3		3	M3 penetrating	17	4	12	6	25	6	5	18	5.5		
10	8 spot face depth 4.4		4	M4 penetrating	20.5	5	12	8	27	6	5	20	7.5		

Allowable lateral load

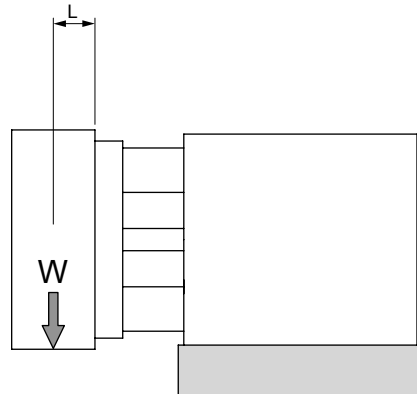
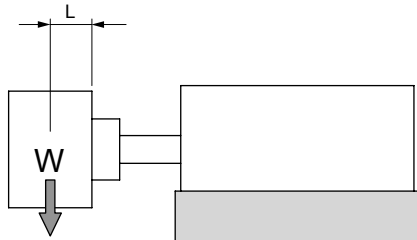

● STM-M-6

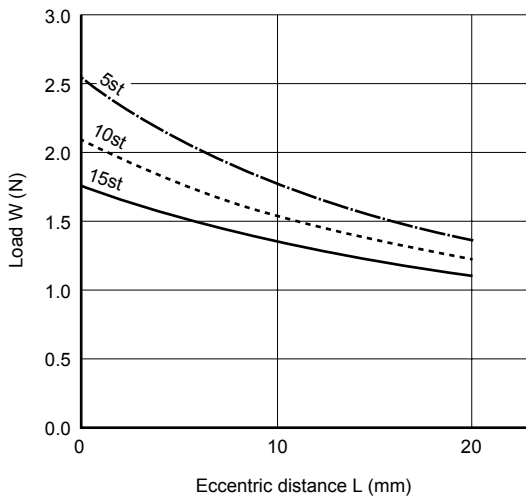

● STM-B-6

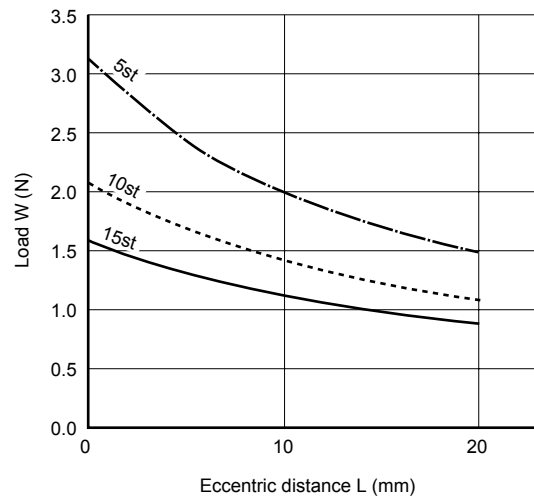

● STM-M-10

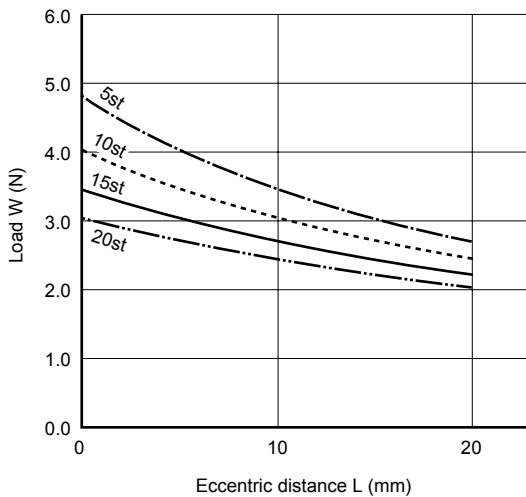

● STM-B-10

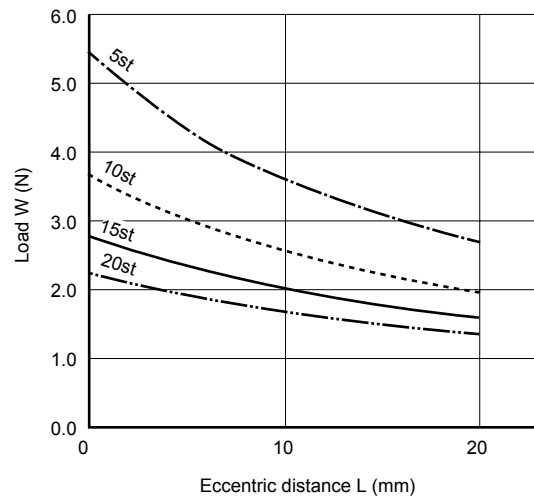

Allowable torque

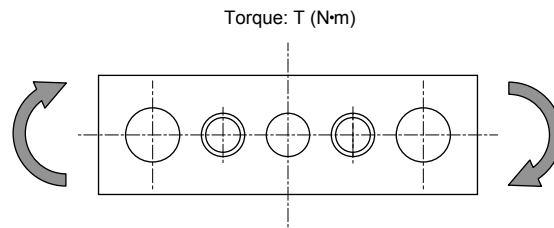

Unit: N·m

Bore size (mm)	Model no.	Type of bearing	Stroke length (mm)			
			5	10	15	20
ø6	STM-M-6	Metal bush bearing	0.015	0.012	0.010	-
	STM-B-6	Ball bearing	0.018	0.012	0.009	-
ø10	STM-M-10	Metal bush bearing	0.030	0.025	0.022	0.019
	STM-B-10	Ball bearing	0.034	0.023	0.018	0.014

Revolvable angle tolerance (reference value)

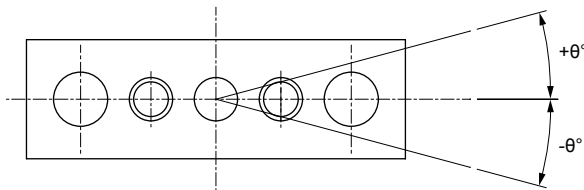

Bore size (mm)	Revolvable angle tolerance θ (degree)	
	Metal bush bearing	Ball bearing
ø6	±0.14	±0.08
ø10	±0.16	±0.08

Allowable absorption energy value

Use in the curve of the lower left range. When using in the upper right range, install the external shock absorber.

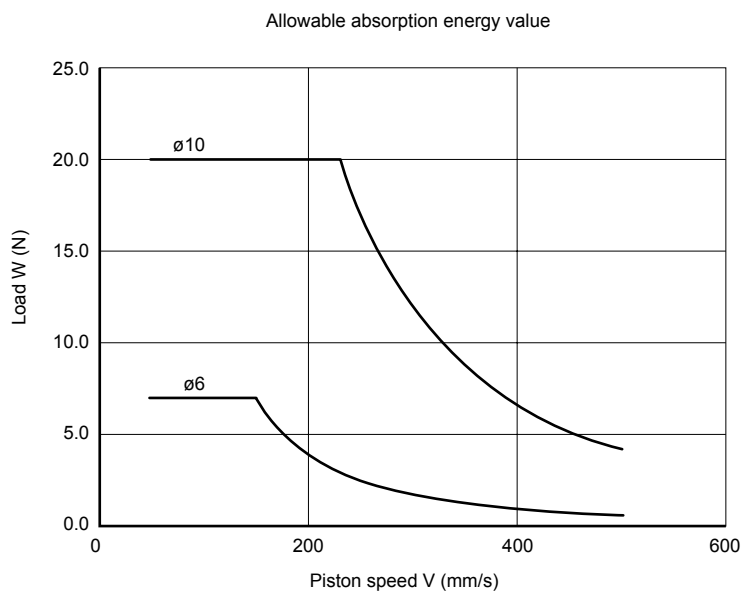

MEMO

Related products

3/4 port pilot operated valve MN3E0/MN4E0 Series

- Dramatically reduced installation space
The 10 mm width and less than 40 mm height (3/4 port valve 2-position) reduces the system's footprint.
- High performance
12 ms high-speed response is balanced on A and B ports.
- Ease of use
To comply with valve downsizing, joint usability has been increased.
A variety of wire connections including 32-point serial transmission is available.
- Environment and safety
Eco-friendly wires are used for internal wiring.
Measures to prevent valve malfunctioning are incorporated.

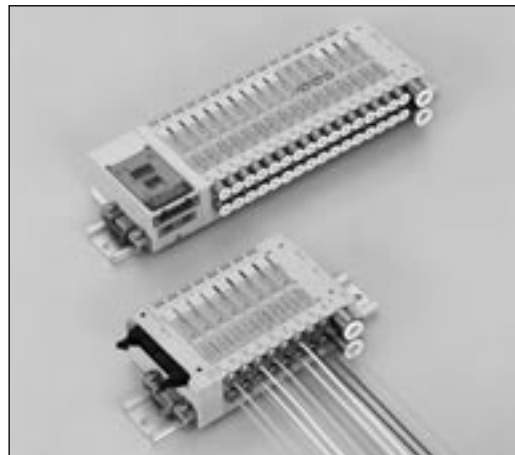

Fiber tube (for push-in joint)

New ultra-thin tube with enhanced usability incorporating enlarged inner diameter and push-in joints

- A new structure is incorporated for outer diameter grasping
- The tube bore is enlarged from $\varnothing 1.0$ to $\varnothing 1.2$, tripling the flow rate
- Small tube piping capacity conserves energy and space
- Clean-room type incorporating corrosion-resistant materials is available as a series
- Push-in joints, standard PG series, and clean-room CG series are available

Catalog No. CB-024SA

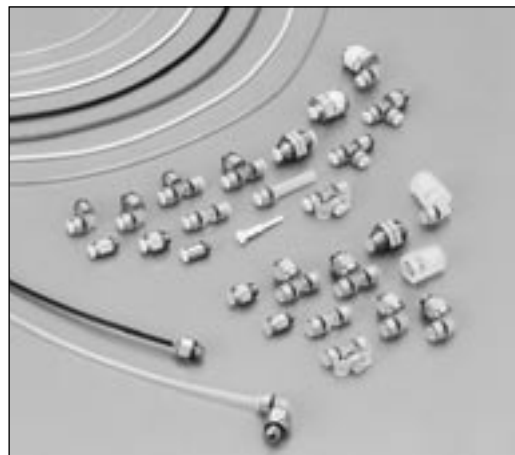

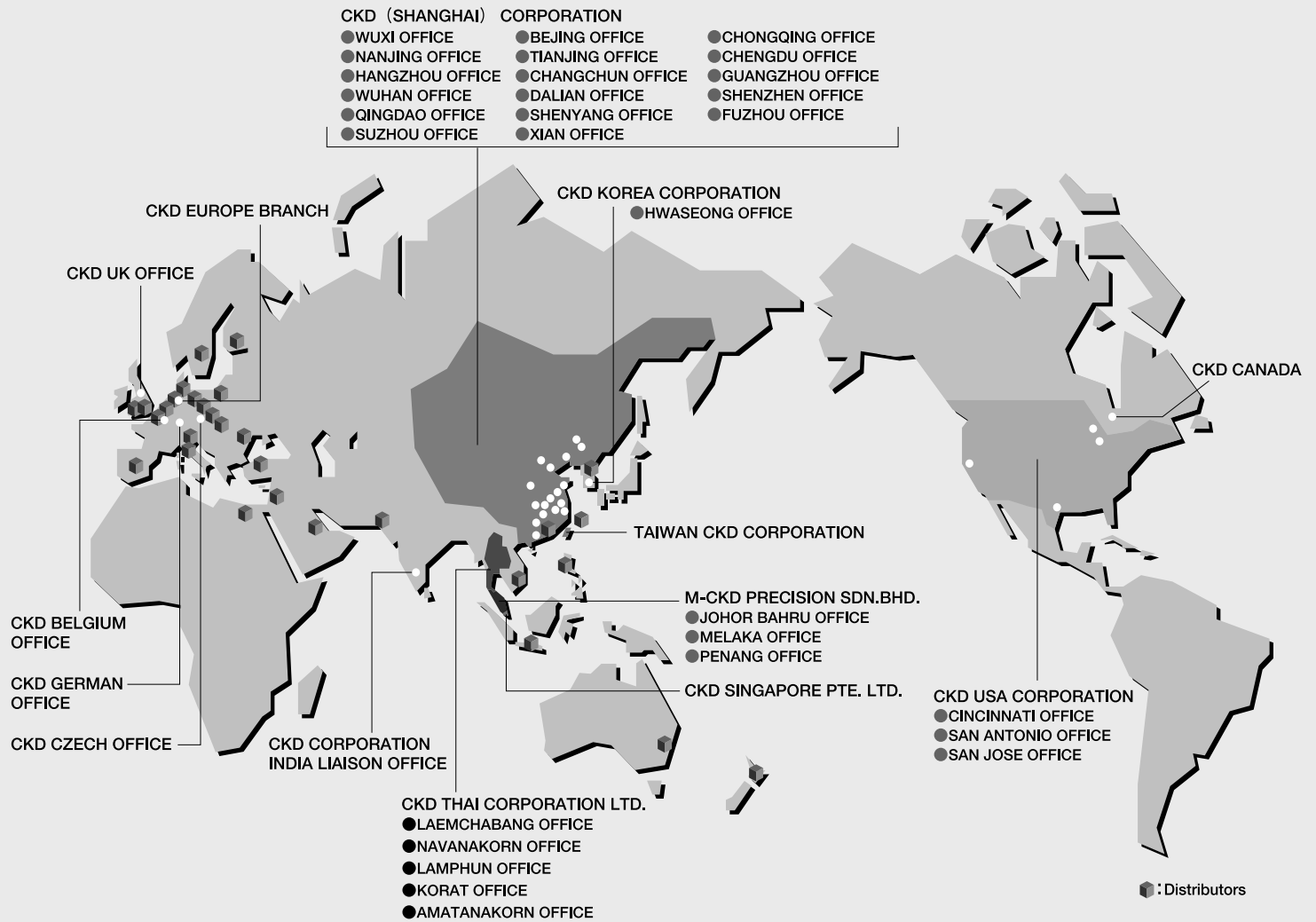

CKD Corporation

Website <http://www.ckd.co.jp/>

□ OVERSEAS DPT. SALES DIV. 2-250 Uji Komaki, Aichi 485-8551, Japan
 □ PHONE +81-(0)568-74-1338 FAX +81-(0)568-77-3461

U.S.A

CKD USA CORPORATION

● HEADQUARTERS

4080 Winnetka Avenue, Rolling Meadows, IL 60008 USA
 PHONE +1-847-368-0539 FAX +1-847-788-0575

EUROPE

CKD EUROPE BRANCH

De Fruittuinen 28 Hoofddorp 2132NZ The Netherlands
 PHONE +31-(0)23-5541490 FAX +31-(0)23-5541491

Malaysia

M-CKD PRECISION SDN.BHD.

● HEADQUARTERS

Lot No.6,Jalan Modal 23/2, Seksyen 23, Kawasan, MIEL,
 Fasa 8, 40300 Shah Alam,Selangor Darul Ehsan, Malaysia
 PHONE +60-(0)3-5541-1468 FAX +60-(0)3-5541-1533

Thailand

CKD THAI CORPORATION LTD.

● SALES HEADQUARTERS-BANGKOK OFFICE

Suwan Tower, 14/1 Soi Saladaeng 1, North Sathorn Rd., Bangrak,
 Bangkok 10500 Thailand
 PHONE +66-(0)2-267-6300 FAX +66-(0)2-267-6305

Singapore

CKD SINGAPORE PTE LTD.

705 Sims Drive #03-01/02, Shun Li Industrial Complex,
 387384 Singapore
 PHONE +65-6744-2623 FAX +65-6744-2486

Taiwan

TAIWAN CKD CORPORATION

1F., No.16, Wucyuan 5th Rd., Wugu Township, Taipei Country 248,
 Taiwan (R.O.C)
 PHONE +886-(0)2-2298-2866 FAX +886-(0)2-2298-0322

China

CKD (SHANGHAI) CORPORATION

● SALES HEADQUARTERS / SHANGHAI OFFICE

Room 1903, 333 Jiujiang Road, Shanghai, 200001, China
 PHONE +86-(0)21-63602277 FAX +86-(0)21-63511661

Korea

CKD KOREA CORPORATION

Room No.1105, 11th FL, The Korea Teachers Pension B/L. 27-2,
 Yoido-Dong, Youngdeungpo-Gu, Seoul, 150-742, Korea
 PHONE +82-(0)2-783-5201~5203 FAX +82-(0)2-783-5204

The goods and their replicas, or the technology and software in this catalog are subject to complementary export regulations by Foreign Exchange and Foreign Trade Law of Japan.
 If the goods and their replicas, or the technology and software in this catalog are to be exported, laws require the exporter to make sure they will never be used for the development or the manufacture of weapons for mass destruction.